

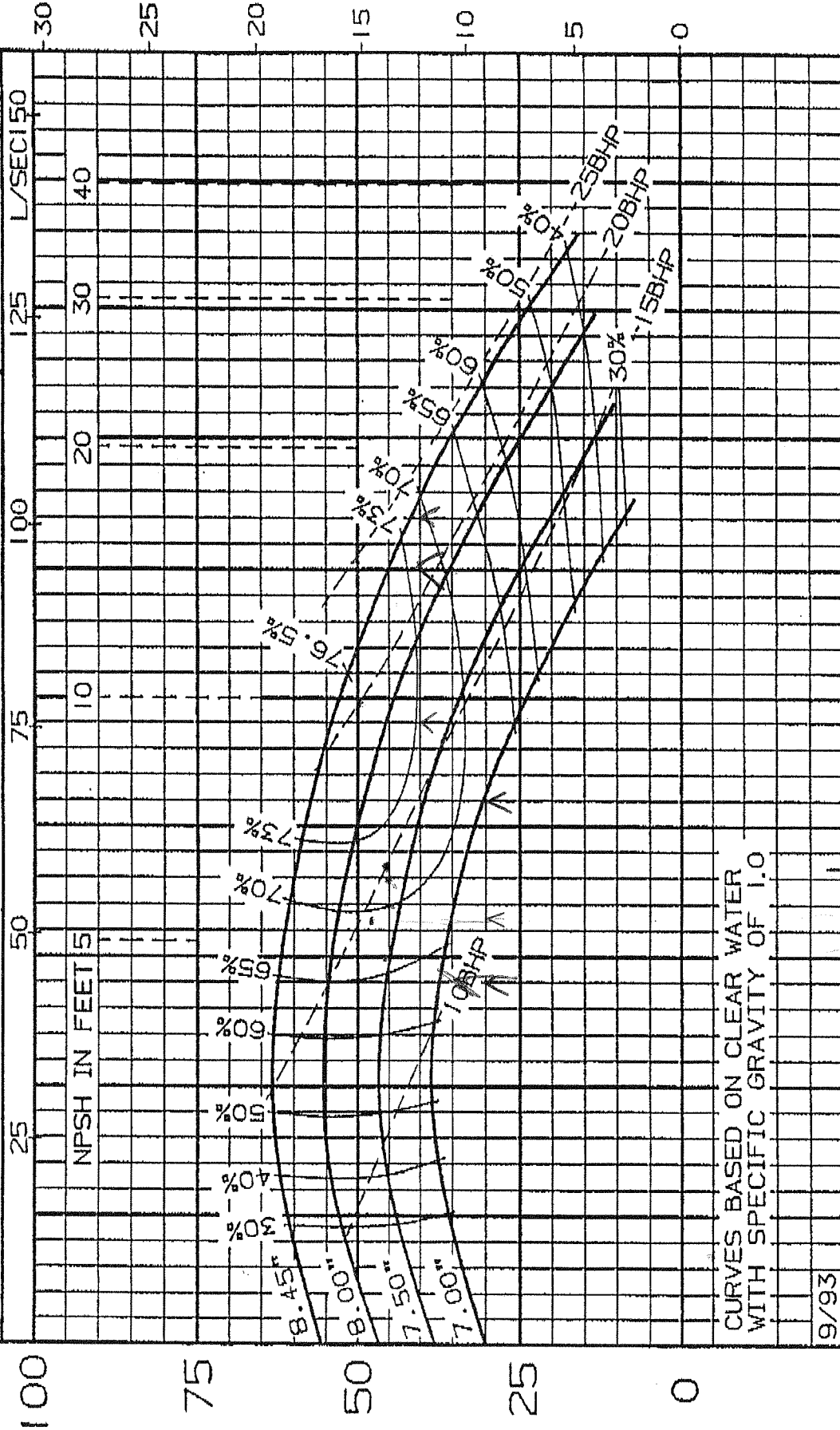

Model 6008
FE Series

1760 RPM

Curve no. 1483
Min. Imp. Dia. 7.0
Size 8 x 6 x 8



CURVES BASED ON CLEAR WATER
WITH SPECIFIC GRAVITY OF 1.0

9/93

0 250 500 750 1000 1250 1500 1750 2000 2250 2500
FLOW IN GALLONS PER MINUTE

SPM 9-16-43

RLB 9-14-85 PC-1483 PC1485 FEB008 1760 EDN2786

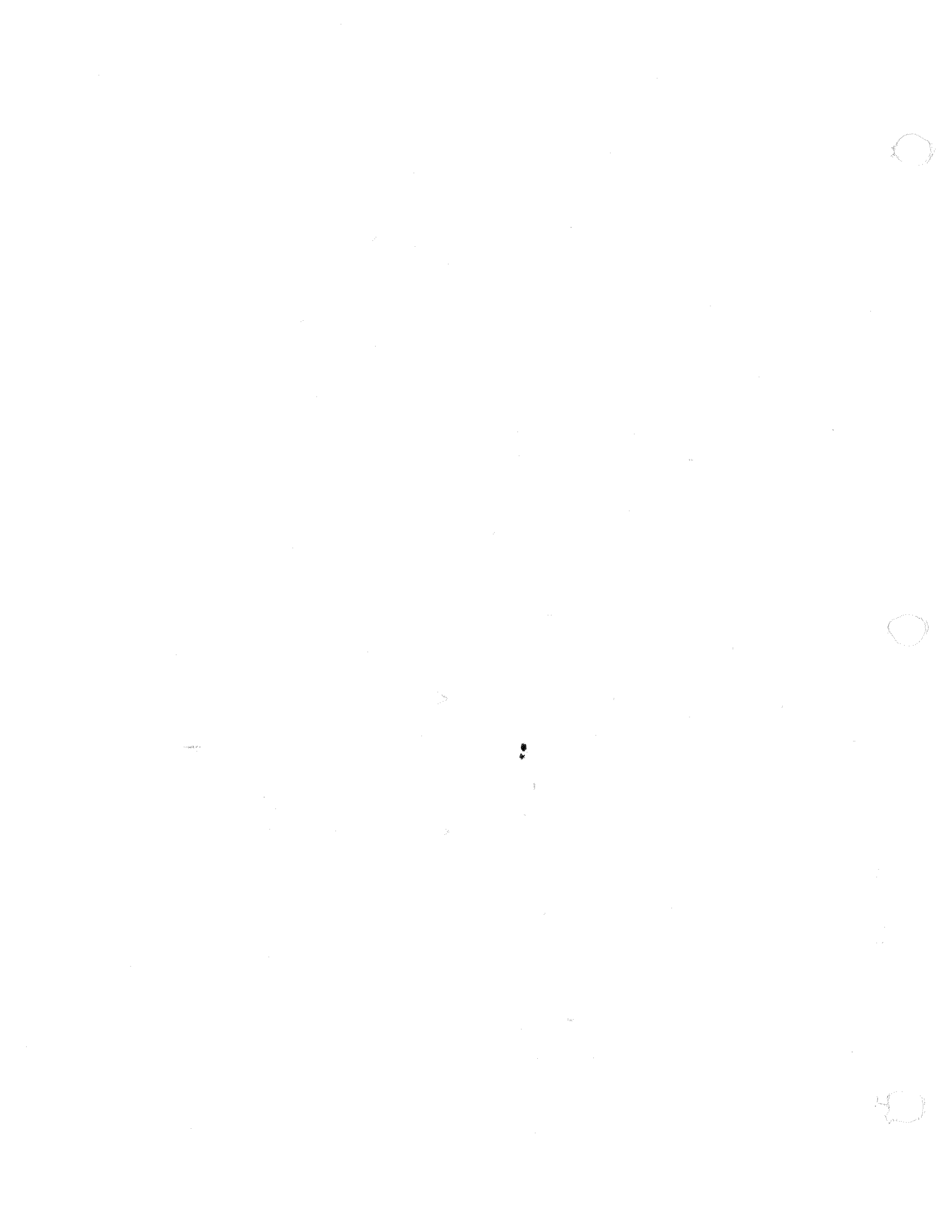

Model No. 5007
CE & FE Series

1760 Series

Curve No. 1484
 Min. Imp. Dia. 5.8
 Size 5 x 5 x 7

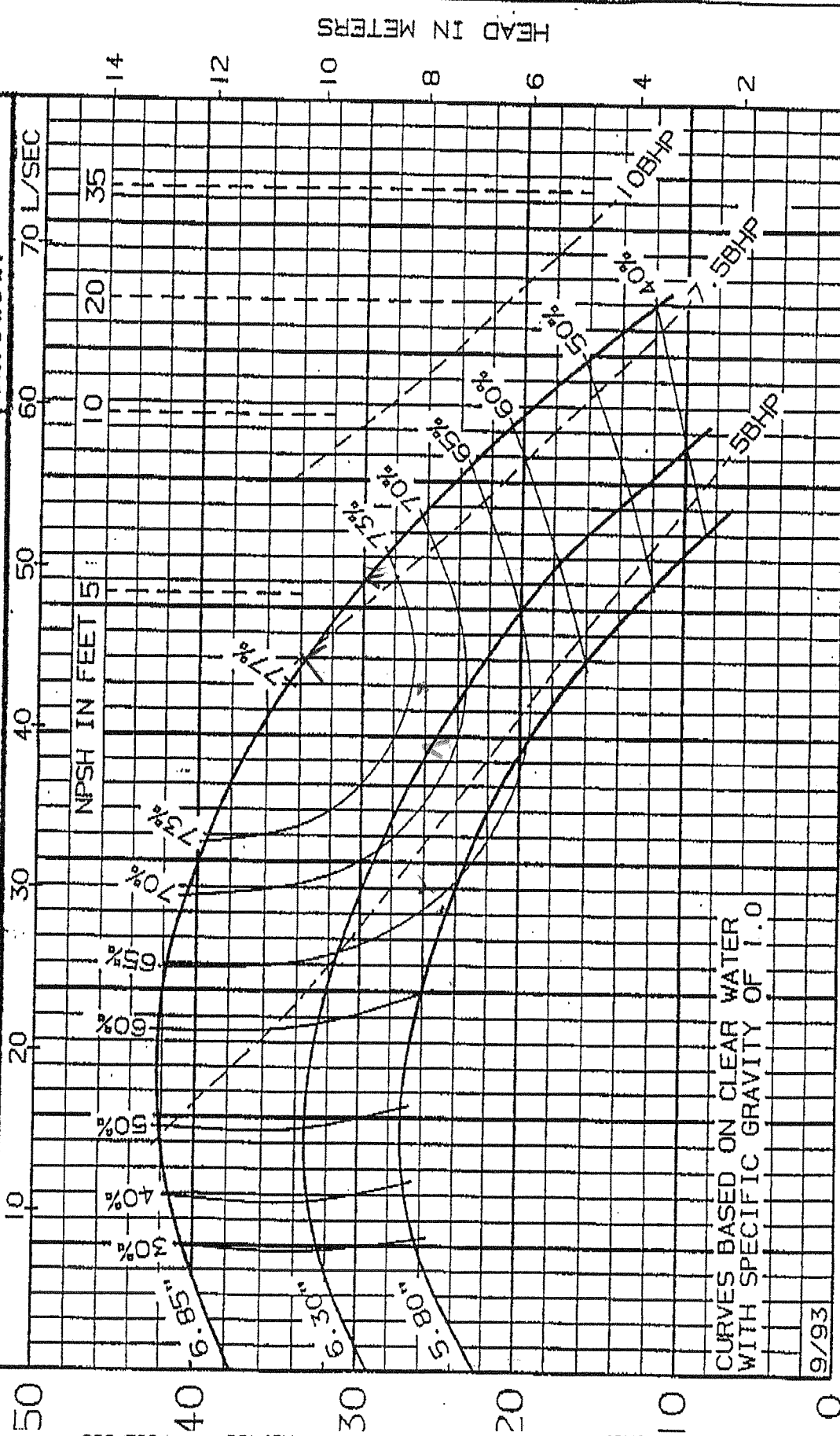

CURVES BASED ON CLEAR WATER
 WITH SPECIFIC GRAVITY OF 1.0

FLOW IN GALLONS PER MINUTE

Model 8010
FE Series

1160 RPM
March 2, 1998

Curve no. 1809
Min. Imp. Dia. 8.62
Size 8 x 8 x 10

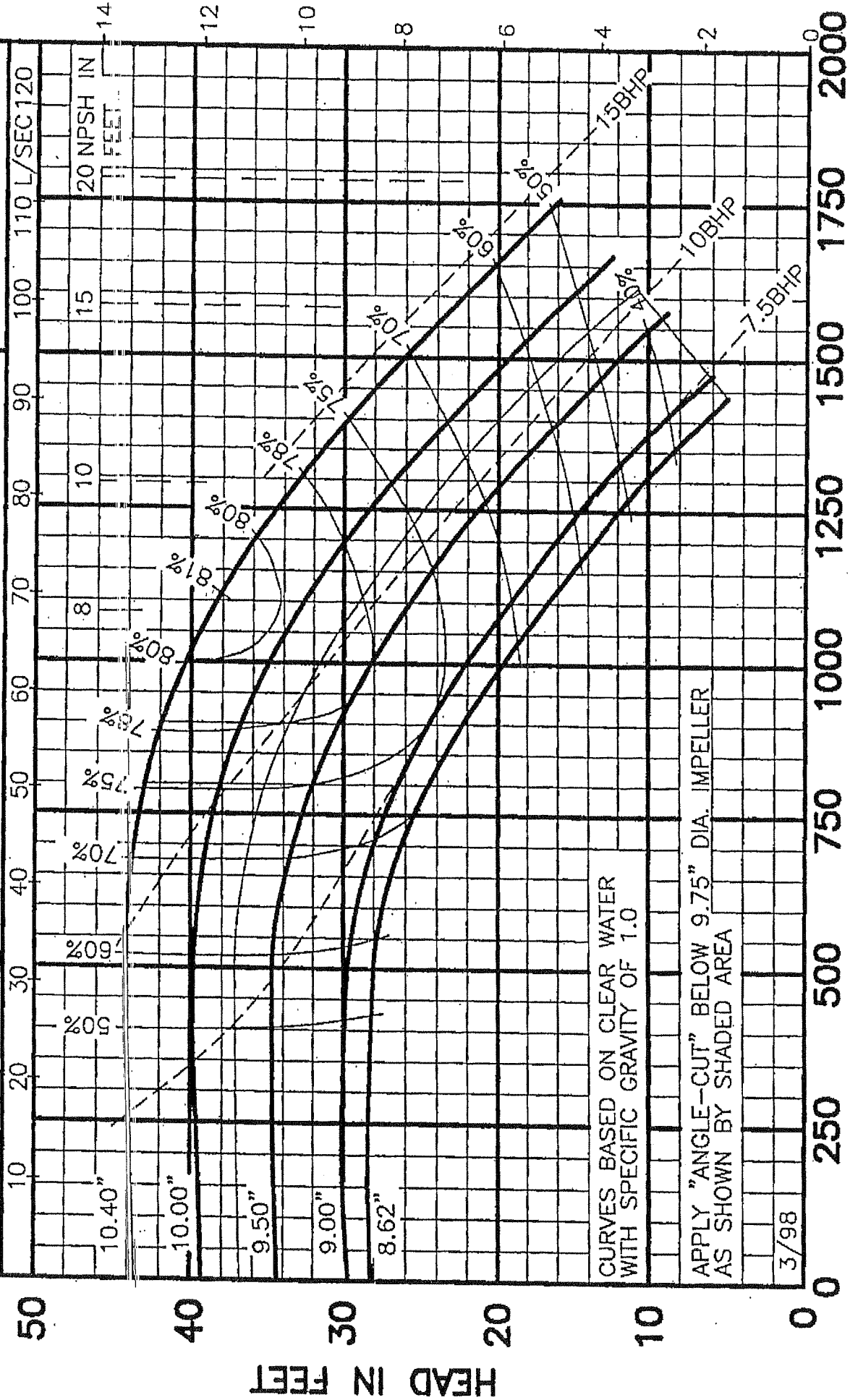

CURVES BASED ON CLEAR WATER
WITH SPECIFIC GRAVITY OF 1.0

APPLY "ANGLE-CUT" BELOW 9.75" DIA. IMPELLER
AS SHOWN BY SHADED AREA

3/98

FLOW IN GALLONS PER MINUTE



FE Series
Model 8010

Speed
1760 RPM

Curve no. 1742
Min. Imp. Dia. 8.62
Size 8 x 8 x 10

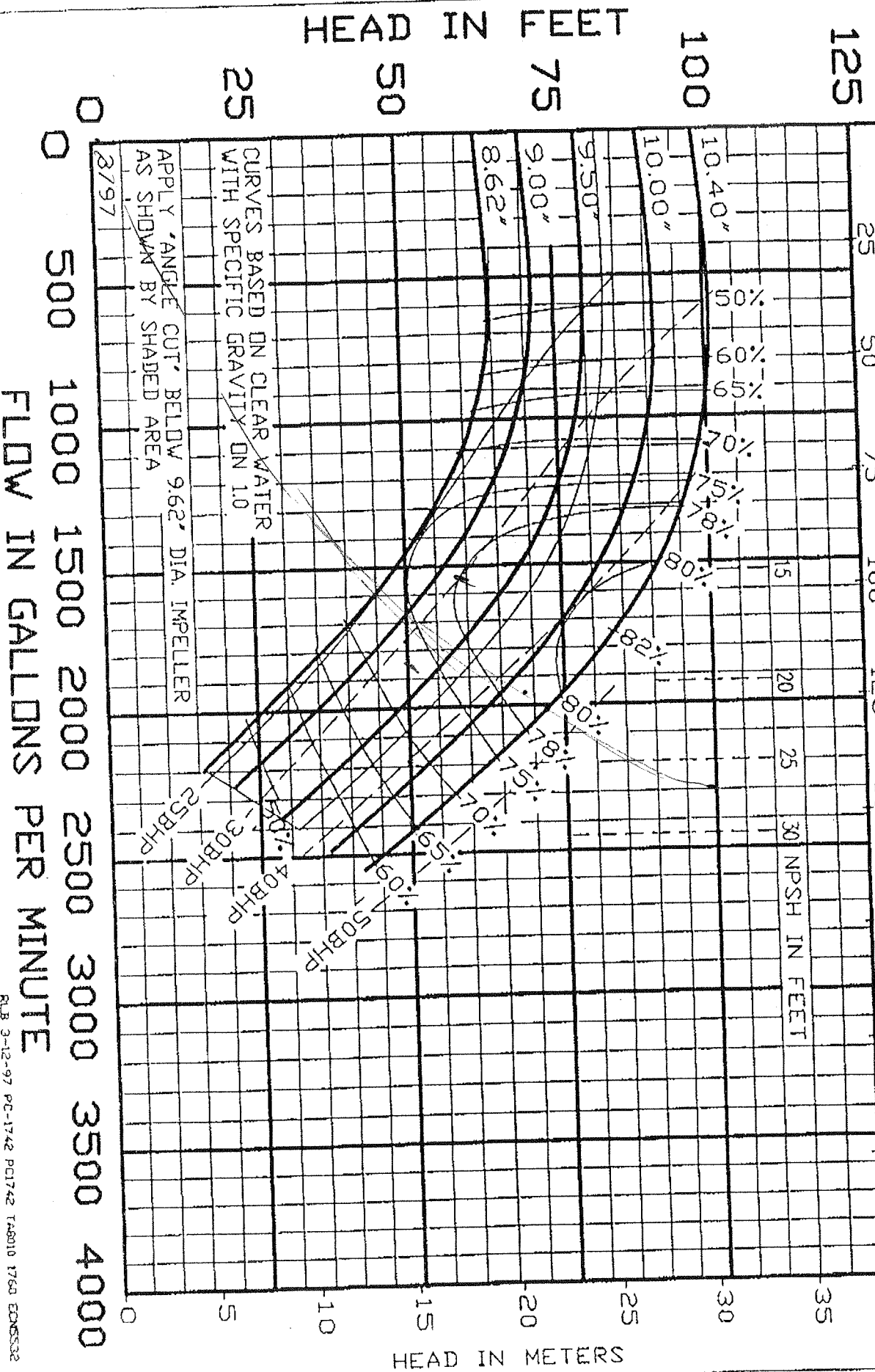

RUB 3-12-97 PC-1742 PCI742 1A8010 1760 EDSS302



10



Submittal Data Information

FE Series Pumps

301-836

EFFECTIVE: November 15, 1993

SUPERSEDES: NEW

1760 RPM MODEL 5007

JOB _____

ENGINEER _____

CONTRACTOR _____ REP. _____

ITEM NO.	MODEL NO.	IMPELLER DIA.	G.P.M.	HEAD/FT.	H.P.	ELEC. CHARS.
----------	-----------	---------------	--------	----------	------	--------------

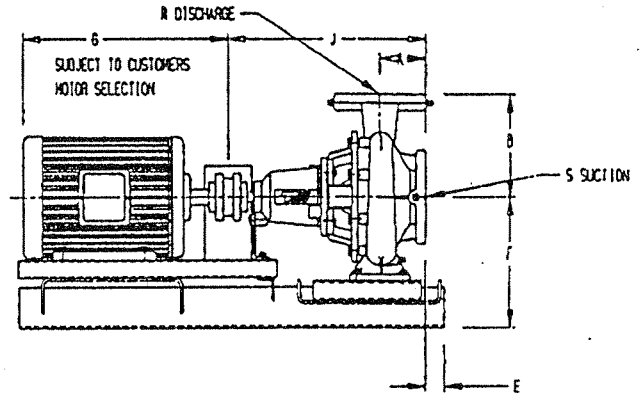
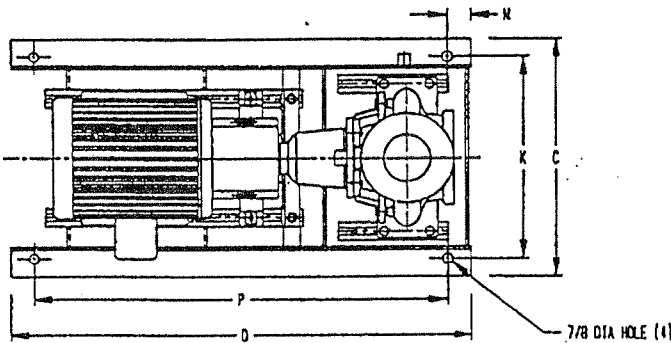

50 Cycle Performance Curves attached when applicable.

Model No.	HP 1160 RPM	HP 1760 RPM	HP 3500 RPM	Motor Frame	A	B	C	D	E	F	J	K	N	P	R	S
5007		1 1-1/2,2 3 5 7-1/2 10		143T 145T 182T 184T 213T 215T	5-5/16	11	20	42	1-1/2	11-3/8	22-17/32	18	2	38	5	5

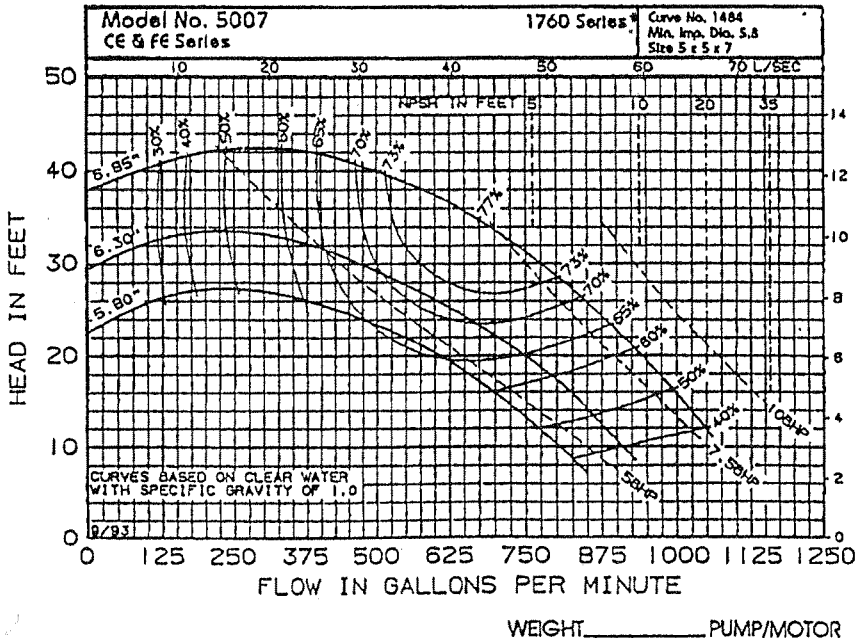

Item	BRONZE FITTED		ALL IRON	
	Std. Pump Constr.	Optional	Standard	Optional
Casing	Cast Iron ASTM A48 Cl. 35		Cast Iron ASTM A48 Cl. 35	
Impeller	Bronze ASTM B30-4A		Cast Iron ASTM A48 Cl. 35	
Wear Ring	Bronze ASTM B30-4A		Bronze ASTM B30-4A	
Shaft	Carbon Steel AISI 1045	St. Steel AISI 418	Carbon Steel AISI 1045	St. Steel AISI 418
Shaft Sleeve	Bronze SAE 680	St. Steel AISI 418	St. Steel AISI 418	
Mech. Seal	Ceramic	Tungsten Carbide	Ceramic	Tungsten Carbide
Seal Flush Line		Copper		Copper

OPERATING SPECIFICATIONS		
	Standard	Optional
Pressure	175 PSIG*	
Temperature: Mechanical Seal	250F	300F
* Motors: All NEMA Standard (T or TS) * In accordance with ANSI Standard B16.1 Class 125		
ADDITIONAL OPTIONS		
Filters	Cuno 5 Micron	
Separators	Kynar Cyclone Separator	
Couplings	Spacer Type	

COMMENTS:

TACO, INC., 1160 Cranston Street, Cranston, RI 02920 (401) 942-8000 FAX: (401) 942-2360.
TACO (Canada), Ltd., 1310 Almco Blvd., Mississauga, Ontario L4W1B2. Telephone: 416/625-2160. FAX: 416/625-8616.

Printed in USA
Copyright 1993
TACO, INC.

Model No. 5007
CE & FE Series

1760 Series

Curve No. 1484
 Min. Imp. Dia. 5.8
 Size 5 x 5 x 7

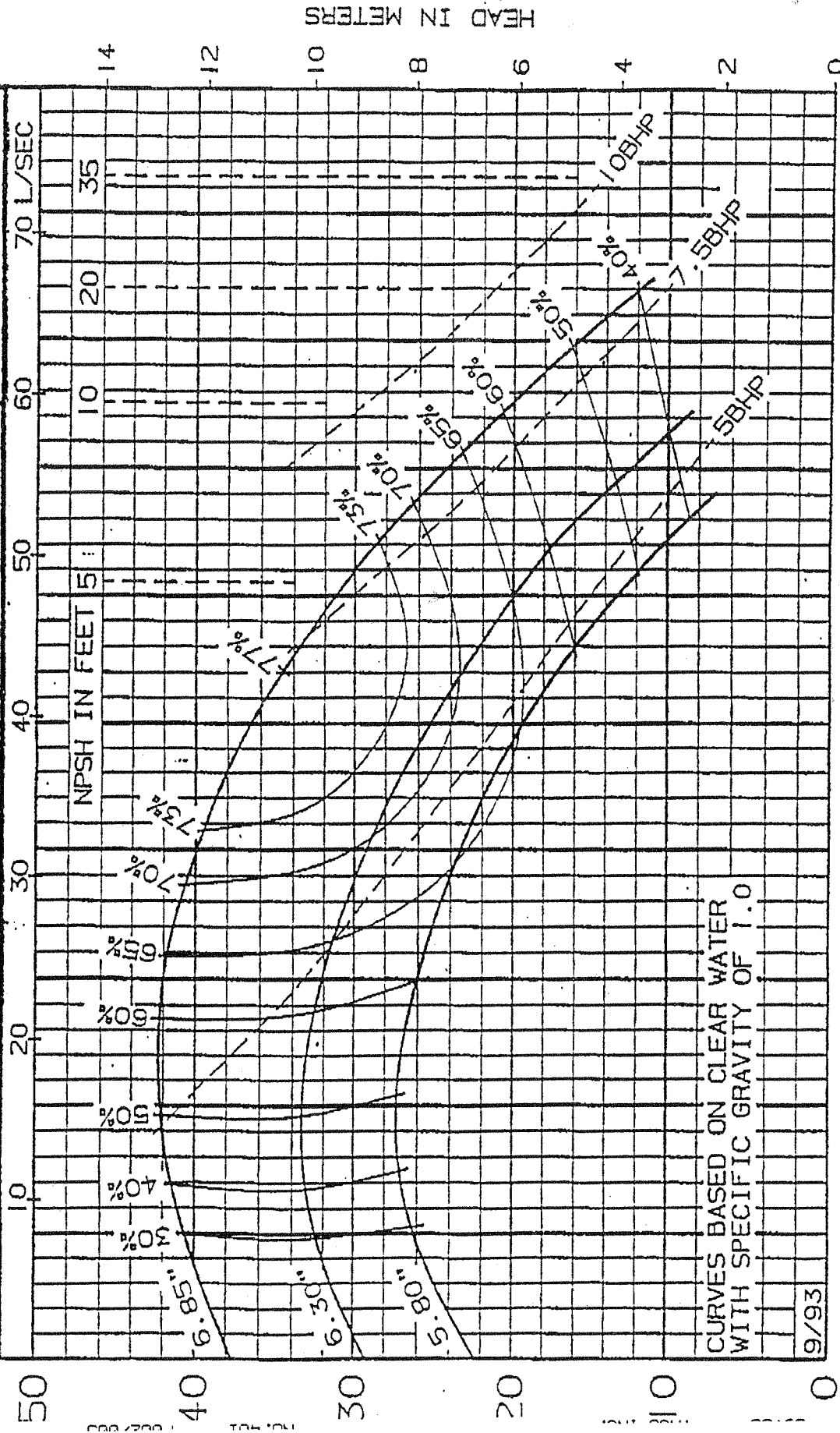

0 125 250 375 500 625 750 875 1000 1125 1250

FLOW IN GALLONS PER MINUTE

HEAD IN METERS

